

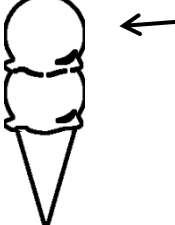

Circle the Blends

sc, sm, sn

Circle the blend that matches each picture.



sc sm sn



sc sm sn



sc sm sn



sc sm sn

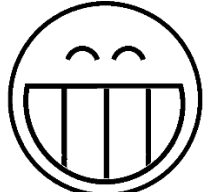

sc sm sn



sc sm sn



sc sm sn

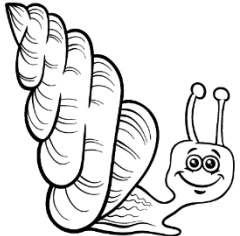

sc sm sn



sc sm sn

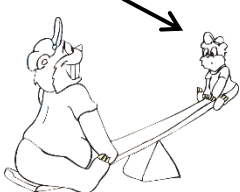

sc sm sn

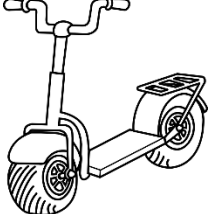

sc sm sn



sc sm sn

Add a matching blend. Draw a picture to match.

__ ale

__ ack

__ ip

__ ooth