

CVC World Boxes

Vowel Mix 2

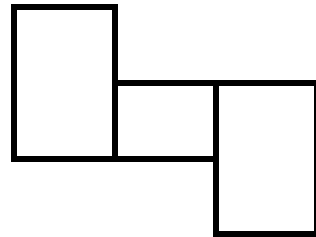

Say the word. Write the word. Box the word.

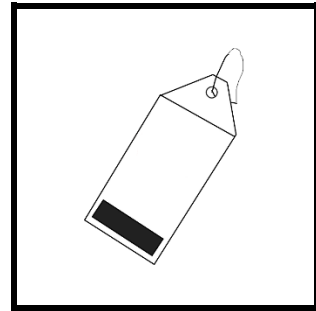
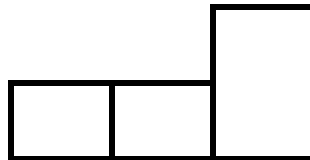
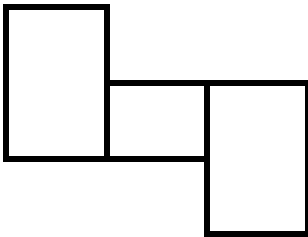
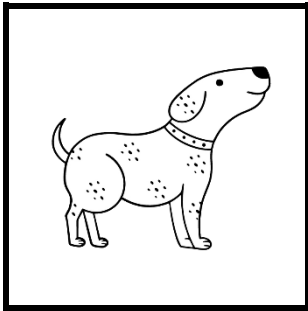
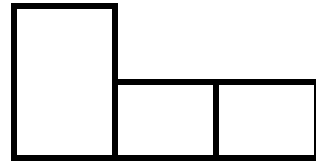
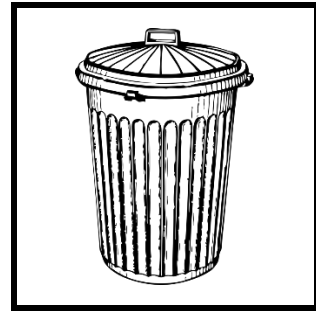
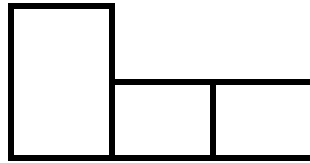
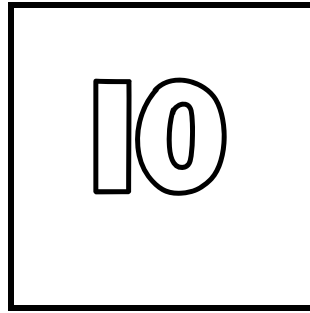
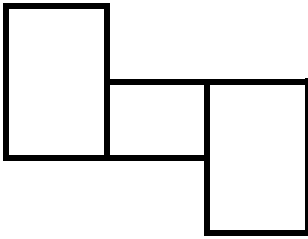
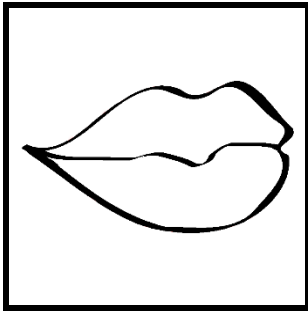
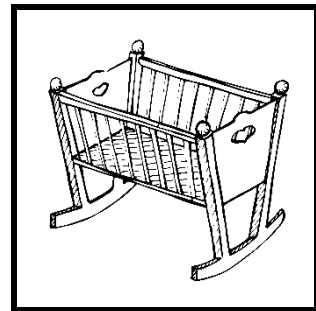
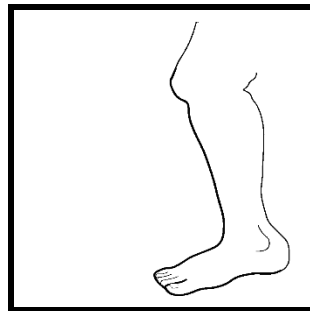
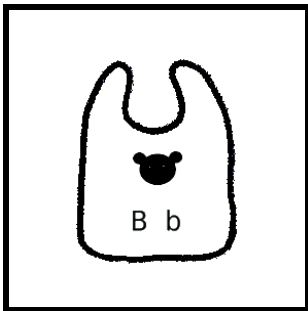

CVC World Boxes

Vowel Mix 2 Answers

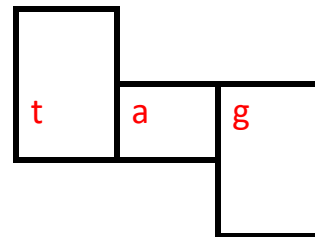
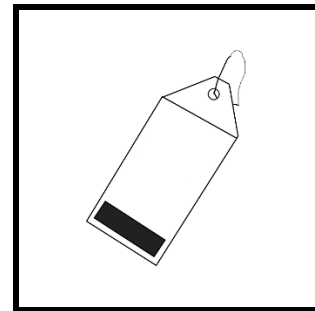
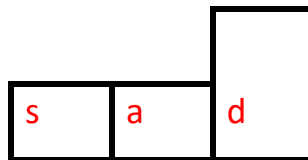
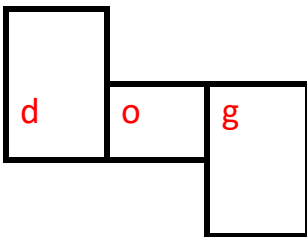
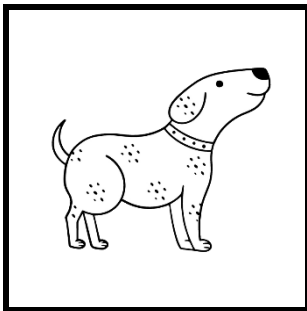
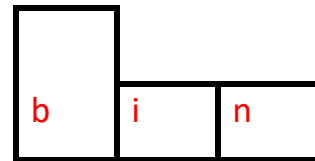
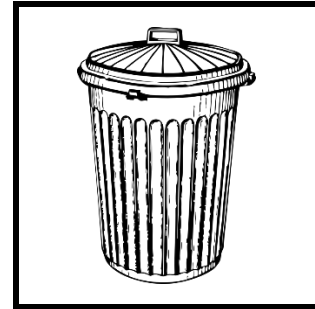
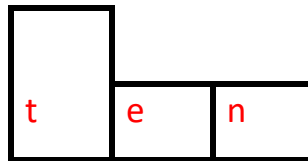
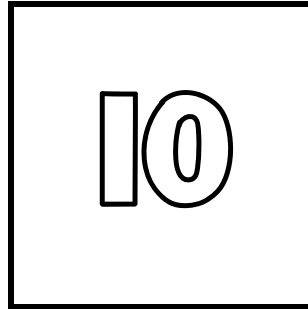
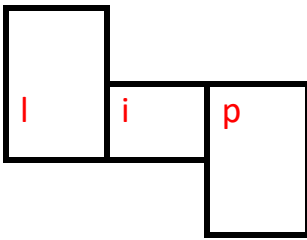
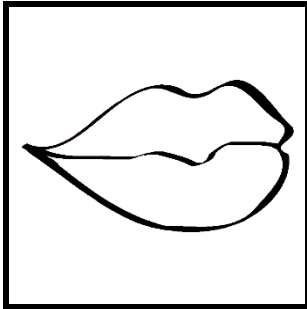

Say the word. Write the word. Box the word.

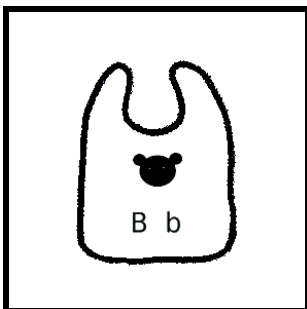

bib

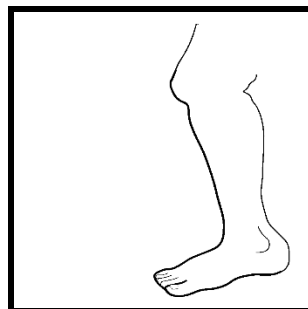

leg

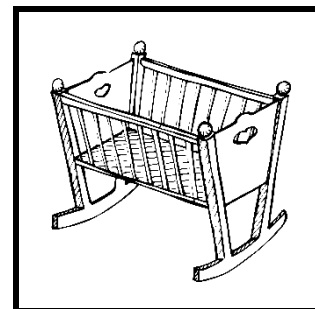

cot