

CVC Word Boxes

Short e Words

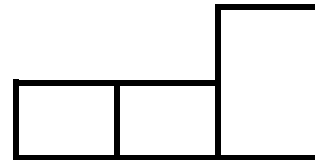

Say the word. Write the word. Box the word.

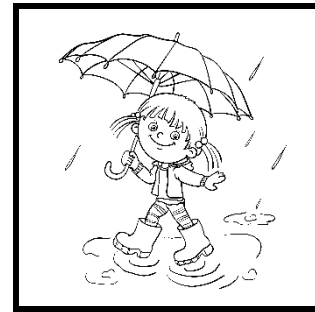
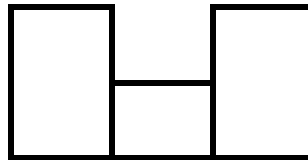
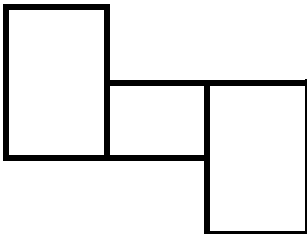
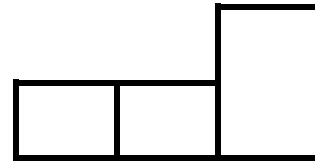
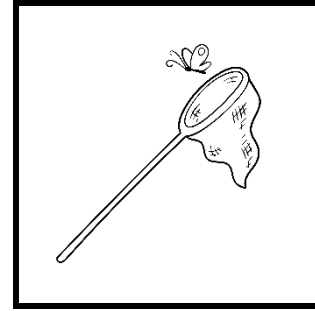
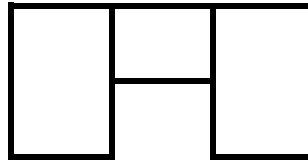
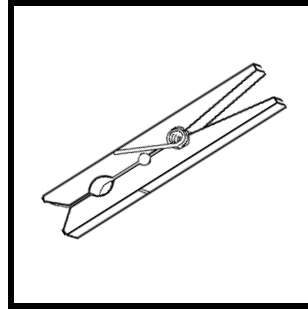
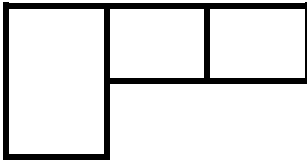
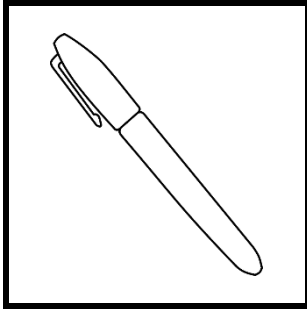
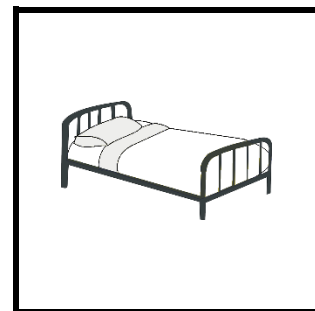
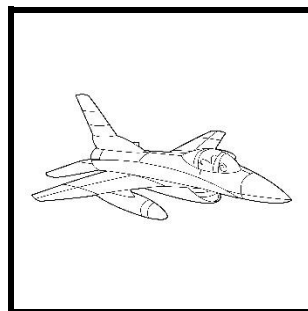
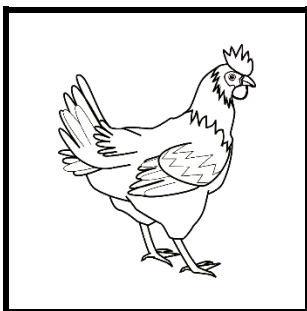

CVC World Boxes Answers

Short e Words

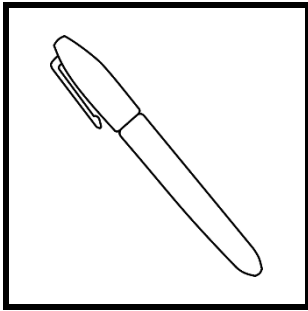

p e n

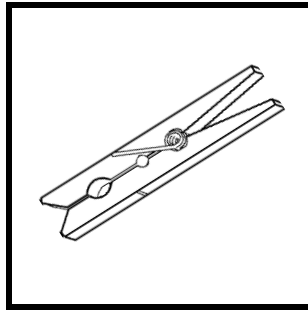

p e g

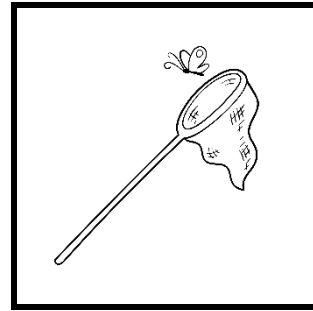

n e t



l e g



f e d

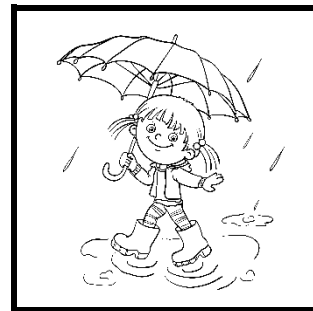

w e t

Say the word. Write the word. Box the word.

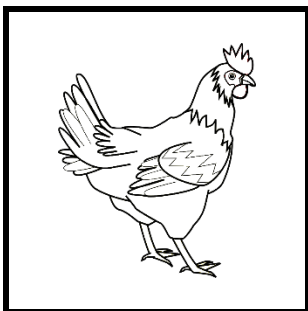

hen

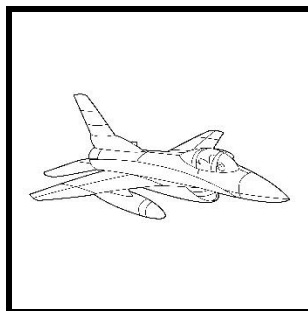

jet

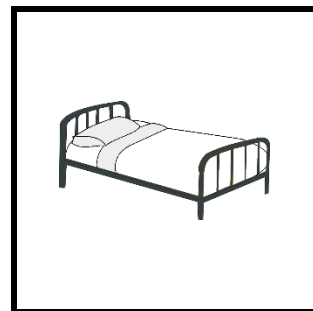

bed