

CVC World Boxes

Short o Words

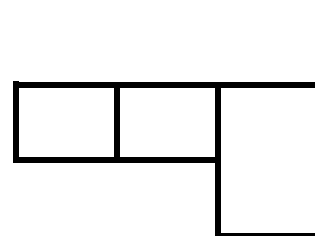

Say the word. Write the word. Box the word.

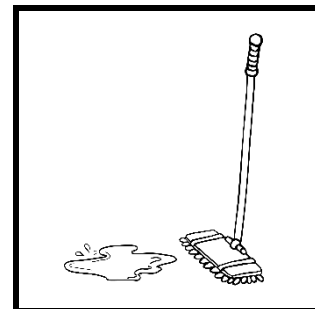
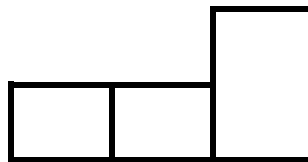
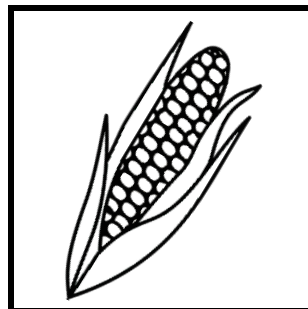
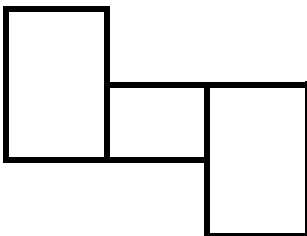
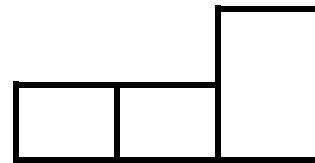
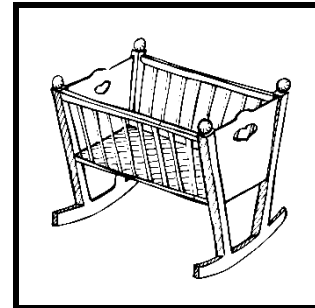
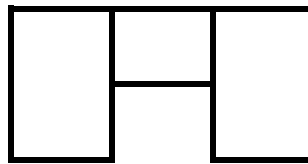
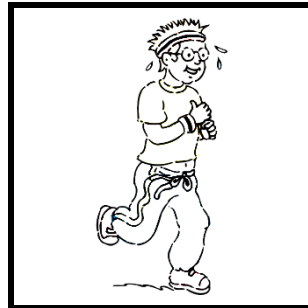
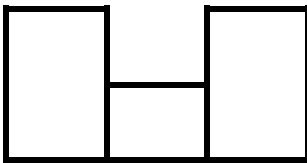
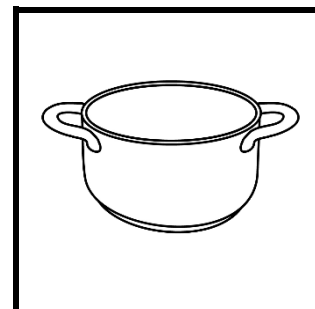
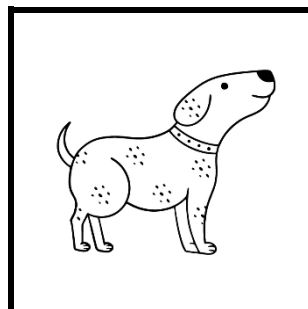
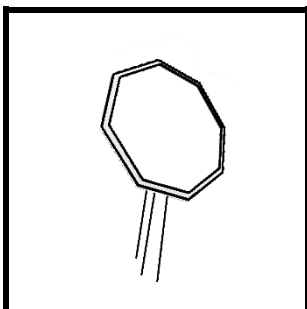

CVC World Boxes Answers

Short o Words



| | | |
|---|---|---|
| h | o | t |
|---|---|---|



| | | |
|---|---|---|
| j | o | g |
|---|---|---|

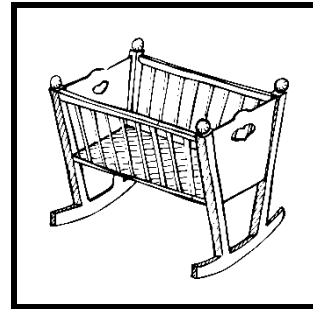

| | | |
|---|---|---|
| c | o | t |
|---|---|---|

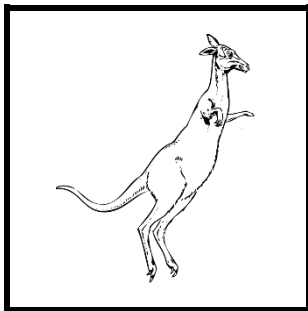

| | | |
|---|---|---|
| h | o | p |
|---|---|---|

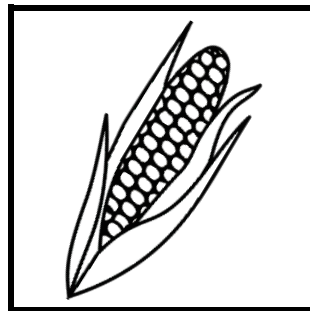

| | | |
|---|---|---|
| c | o | b |
|---|---|---|

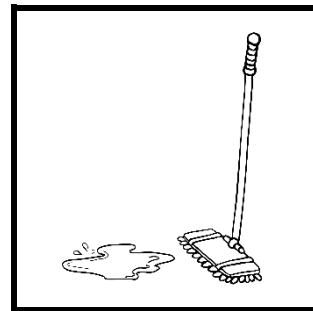

| | | |
|---|---|---|
| m | o | p |
|---|---|---|

Say the word. Write the word. Box the word.

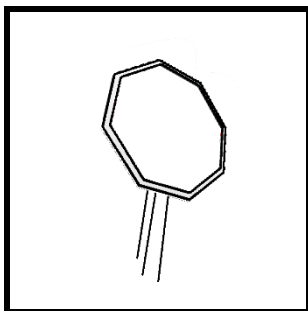

stop

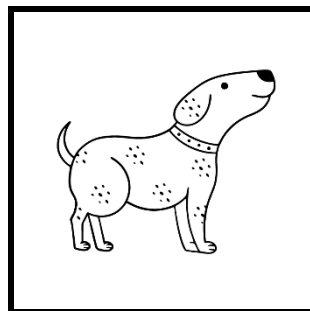

dog

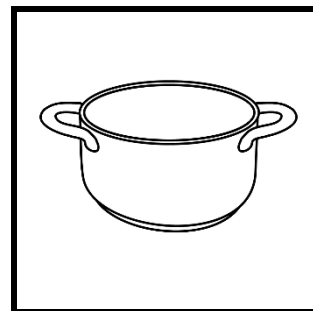

pot