







Identifying Initial Sounds

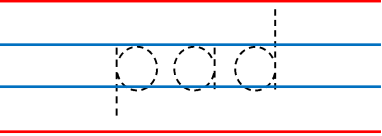

CVC Words Sheet 5

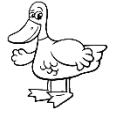
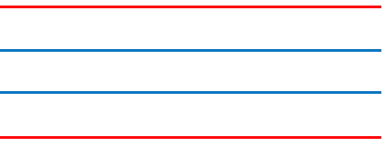
Say each word. Write the beginning sounds.	Join the sounds together to make a new word.	Draw.
---	---	-------

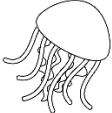
 _____	 _____	 _____	
--	--	--	---

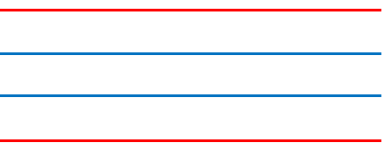
 _____	 _____	 _____	
--	--	--	---

 _____	 _____	 _____	
--	--	--	--

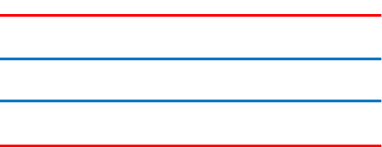
 _____	 _____	 _____	
--	--	--	---



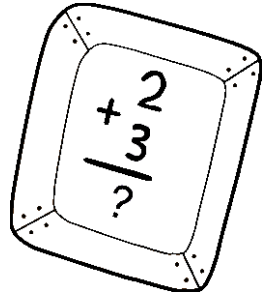
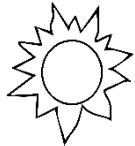



Say. Write. Draw a picture to match each of the three sounds. One has been done for you.

		 	
		S	

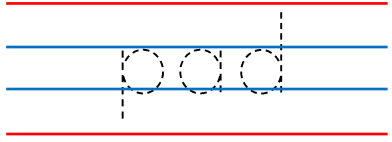

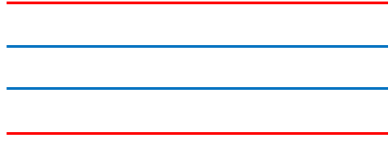
Identifying Initial Sounds **Answers**

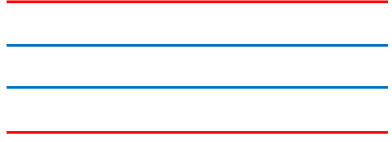
CVC Words Sheet 5

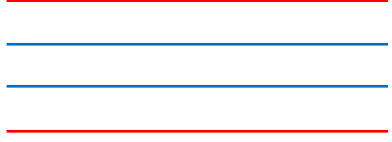
Say each word. Write the beginning sounds.	Join the sounds together to make a new word.	Draw.
 <p>p a d</p>		<p>pad</p>
 <p>m u d</p>		<p>mud</p>
 <p>j e t</p>		<p>jet</p>
 <p>s a p</p>		<p>sap</p>

Say. Write. Draw a picture to match each of the three sounds. One has been done for you.

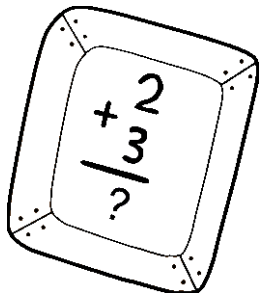
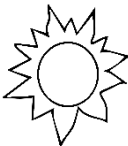
			
	s	u	m

			
	b	a	g