

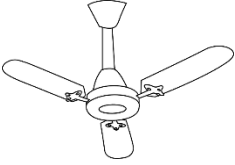





# Sound Chains



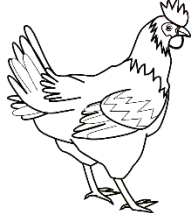
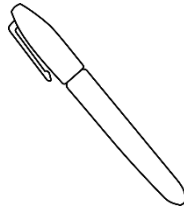

## Initial Sounds

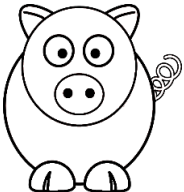
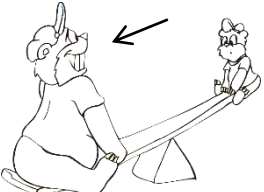
1. Change the **first** sound to create new words.

	→		→		→	
○ a n		○ _ _		○ _ _		○ _ _

10	→		→		→	
○ e n		○ _ _		○ _ _		○ _ _

	→		→		→	
○ i g		○ _ _		○ _ _		○ _ _

	→		→		→	
○ o t		○ _ _		○ _ _		○ _ _



2. **Create your own word chain** by changing one letter at a time.



	→		→		→	
_ _ _		_ _ _		_ _ _		_ _ _

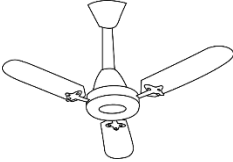

# Sound Chains **Answers**



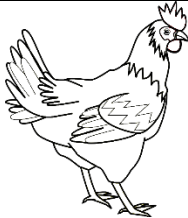
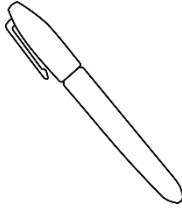

## Initial Sounds

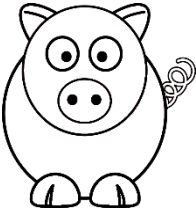
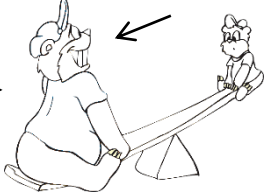
1. Change the **first** sound to create new words.

	→		→		→	
<b>v</b> a n		f a n		m a n		p a n

10	→		→		→	
<b>t</b> e n		h e n		p e n		m e n

	→		→		→	
<b>p</b> i g		b i g		d i g		w i g

	→		→		→	
<b>p</b> o t		c o t		h o t		d o t

2. **Create your own word chain** by changing one letter at a time.

	→		→		→	
<b>c</b> a b		<b>A</b> n s w e r s		<b>w</b> i l l		<b>v</b> a r y .