



Probability Match

Show the probability of each event by cutting and pasting the probability words.

Flipping a coin 10 times and getting tails each time

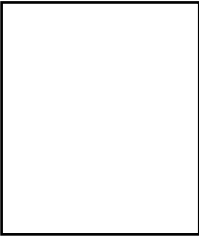

Rolling an even number on 6-sided dice

Playing 5 games of Rock Paper Scissors and winning at least 1

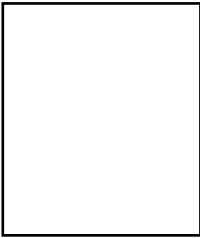

Picking a letter 't' from the bag

Spinning the spinner and not landing on 1

Picking a striped jellybean from the bag

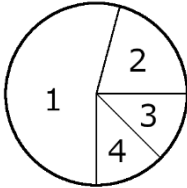
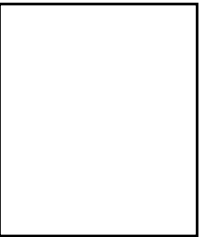
likely	even chance	unlikely
impossible	unlikely	likely

Probability Match **Answers**

Show the probability of each event by cutting and pasting the probability words.

Flipping a coin 10 times and getting tails each time

unlikely



Rolling an even number on 6-sided dice

even chance



Playing 5 games of Rock Paper Scissors and winning at least 1

likely



Picking a letter 't' from the bag

impossible



Spinning the spinner and not landing on 1

unlikely

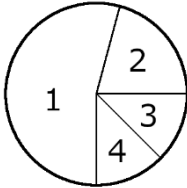

Picking a striped jellybean from the bag

likely

