

# CVC Word Boxes

## Short e Words

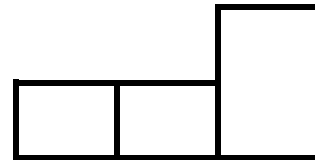

Say the word. Write the word. Box the word.

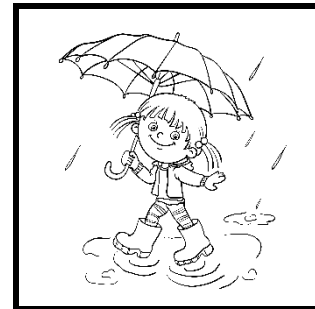
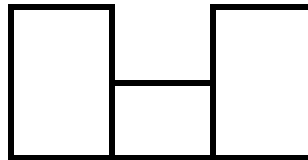
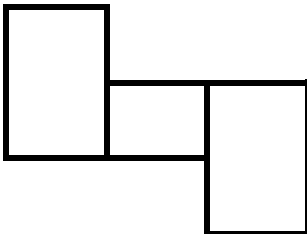
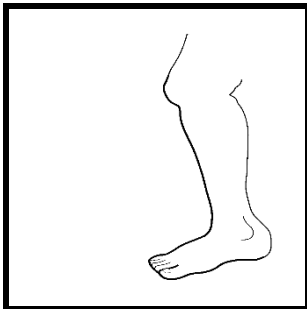
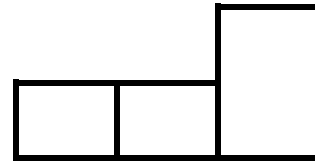
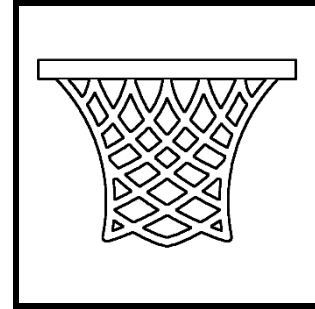
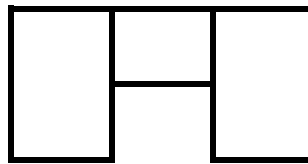
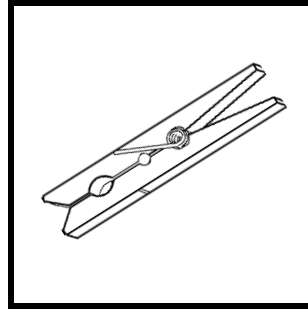
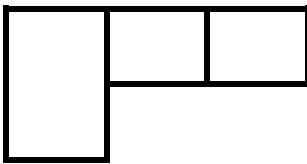
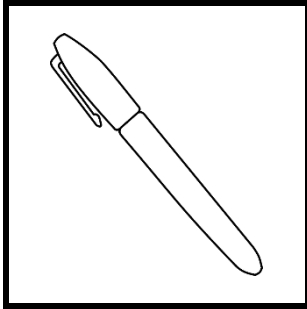
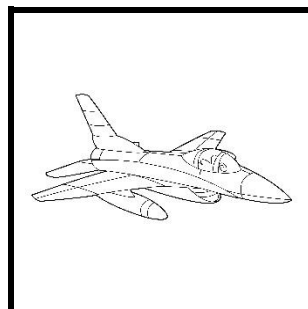
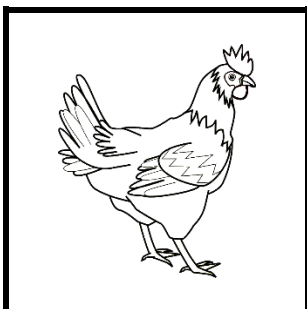

# CVC World Boxes Answers

## Short e Words

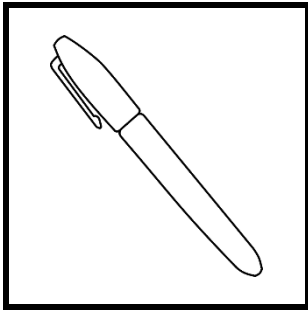

p	e	n
---	---	---

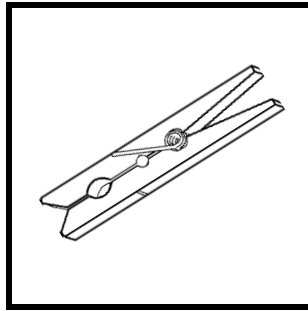

p	e	g
---	---	---

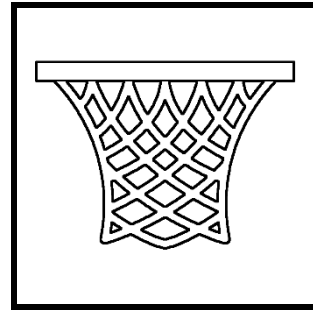

n	e	t
---	---	---

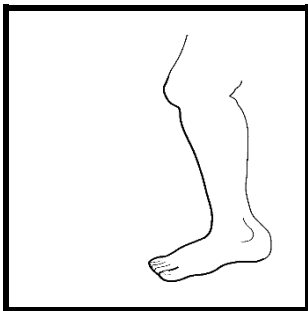

l	e	g
---	---	---



f	e	d
---	---	---

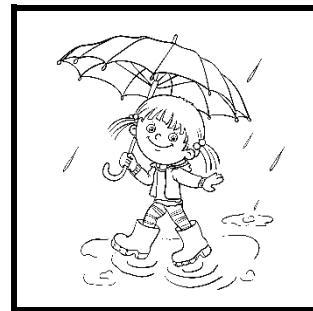

w	e	t
---	---	---

Say the word. Write the word. Box the word.

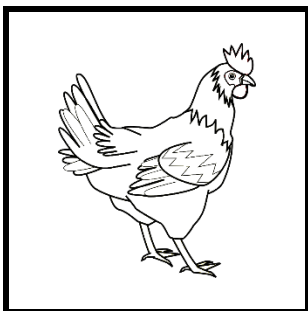

hen

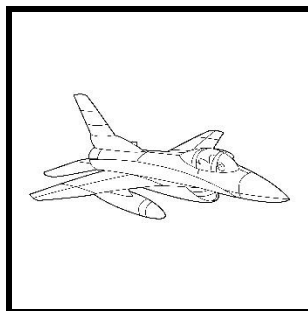

jet

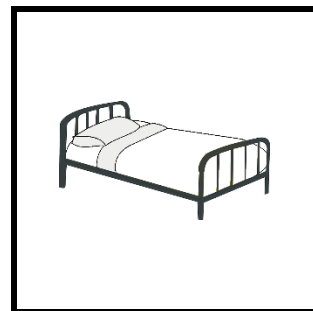

bed